

VELTIA is an innovative hand dryer that operates without heating element. It operates automatically when putting your hands in the drying chamber. It works based on high speed air flow, allowing dry your hands in a very short time leaving on the skin a nice feeling of massage.

Besides a great effectiveness, **VELTIA** includes a bad scents elimination system thanks to **ZEROSMELL** (sold separately).
Optional: Hepa Filter H12 (total retention $\geq 99.5\%$)

VELTIA is ideal for washrooms with medium and high number of users per day.

Patent Number: **WO / 2006 / 042896**

TECHNICAL, ENVIRONMENTAL AND MECHANICAL SPECIFICATIONS

MODEL:	240 V	120 V
Voltage	220/230/240V~	110/120V~
Frequency	50/60 Hz	50/60 Hz
Power Consumption	1.760 W	1.749 W
Current (when running)	8.0A @ 230Vac	15.9A @ 120Vac
Electrical Isolation	Class II	Class II
Air Speed	340 Km/h (211 mph)	340 Km/h (211 mph)
Drying Time	6-8 s	6-8 s
Dimensions	300 x 195 x 617 (mm)	300 x 195 x 617 (mm)
	11.81x7.67x24.29 (inches)	11.81x7.67x24.29 (inches)
Weight	9.55 Kg (21.1 Lb)	9.55 Kg (21.1 Lb)
IP Code	IPX1	IPX1
Noise (@ 2 mt)	70 dB	70 dB
Number of Motors	2	2
Motors Speed	30.000 rpm	30.000 rpm
Motors Driving System	Soft Starting	Soft Starting
Hands Detection System	IR - Barrier	IR - Barrier

MATERIALS

Housing case and water tank made of High impact 2.6 mm thick ABS with antibacterial protection in drying area.

All plastic pieces are properly prepared for recycling.

According to directive ETL in our hand dryers of 120 V and 240 V, internal parts may be made of fire retardant plastic rated 5VA.

Veltia complies with the following directives: ROHS (Restriction of Hazardous Substances) and RAEE (Collection of electrical and electronic equipment and waste management).

DIMENSIONS

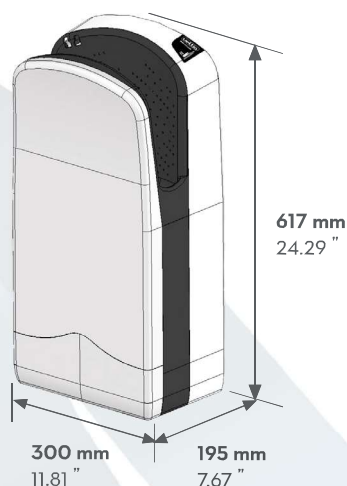

CERTIFICATIONS

CB Test Certificate
CE Conformity Declaration(*)

(*) According to European Directives:
Low Voltage Directive (LVD) 2006/95/CE and
Electromagnetic Compatibility Directive (EMC) 2004/108/CE

Other Certifications:

ANCE NOM (Mexico)
SABS (South Africa)
SII - The Standards Institution of Israel
New Zealand and Australian Standards
GMARK (Gulf)
SASO (Saudi Arabia)

Product information subject to changes without further notice

Rev.:1.3

July 2019

www.veltia.com

1/2

RECOMENDED HEIGHTS FOR INSTALLATION

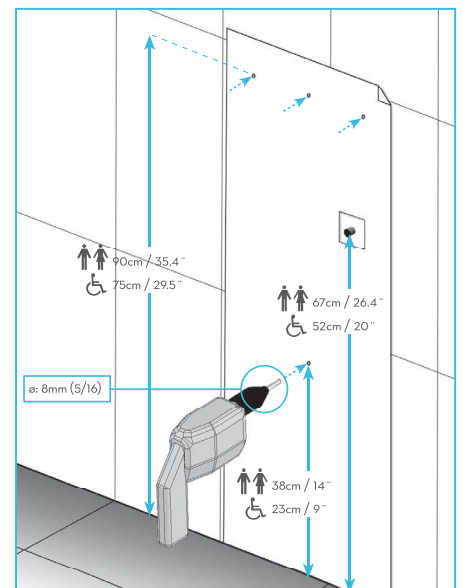
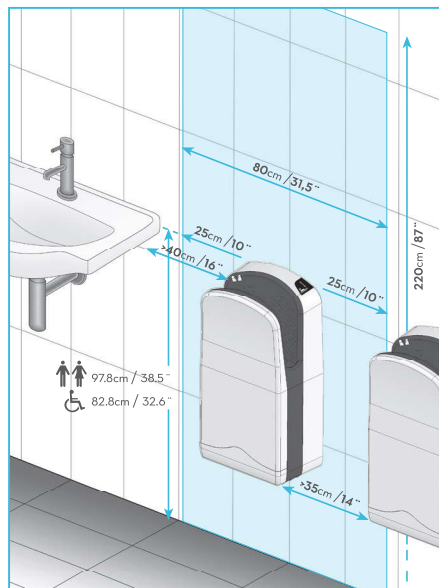
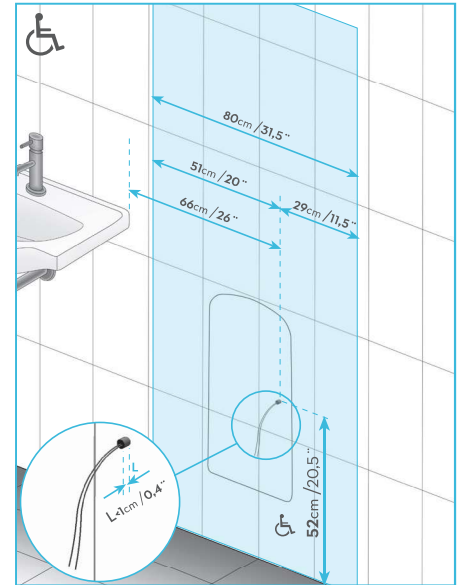
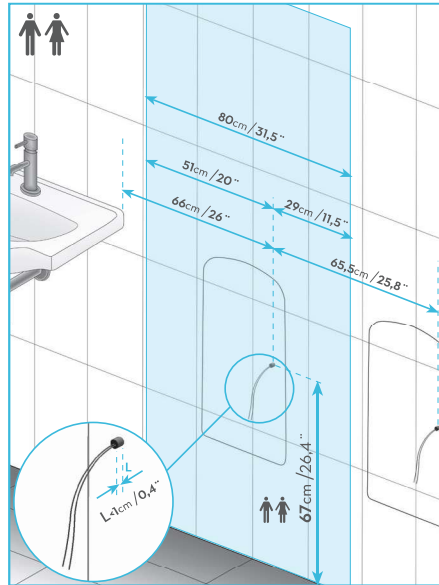

MAINTENANCE

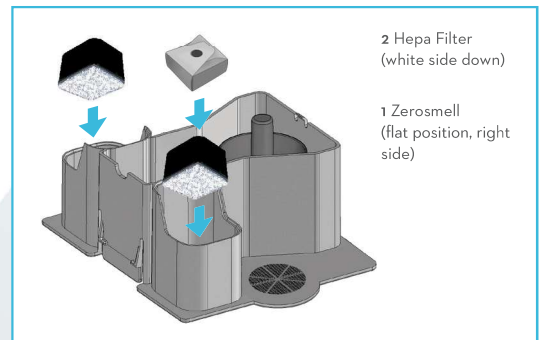
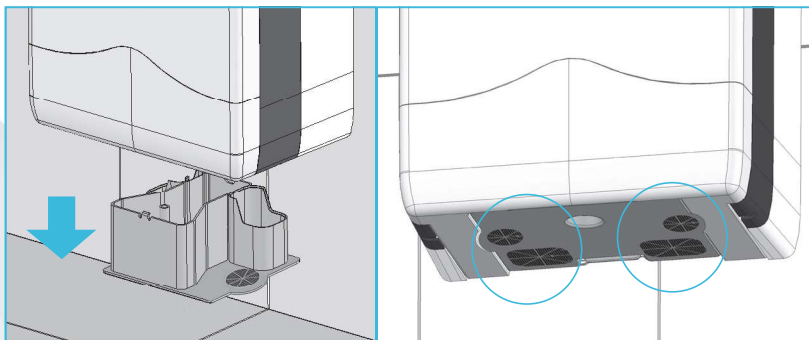

The basic maintenance consists in emptying the water tank and cleaning the air filters following the instructions of the user's manual. An electronic device warns (audible and visual alarm) if maintenance is required.

Optionals:
Zeromell and Hepa Filter